

CITY MULTI

**Air-Conditioners For Building Application
INDOOR UNIT**

PKFY-WL·VLM Series

OPERATION MANUAL

For safe and correct use, please read this operation manual thoroughly before operating the air-conditioner unit.

FOR USER

English



Manual Download



<http://www.mitsubishielectric.com/ldg/ibim/>

en Go to the above website to download manuals, select model name, then choose language.

Contents

1. Safety Precautions	1	5. Emergency Operation for Wireless Remote-controller	10
2. Parts Names	2	6. Care and Cleaning	11
3. Operation	7	7. Troubleshooting	13
4. Timer	10	8. Specifications	15

Note:

The phrase "Wired remote controller" in this operation manual refers to the PAR-40MAA.
If you need any information for the other remote controller, please refer to the instruction book included in this box.

1. Safety Precautions

- ▶ Before installing the unit, make sure you read all the "Safety Precautions".
- ▶ The "Safety Precautions" provide very important points regarding safety. Make sure you follow them.
- ▶ Please report to or take consent by the supply authority before connection to the system.

Symbols used in the text

- ⚠ **Warning:**
Describes precautions that should be observed to prevent danger of injury or death to the user.
- ⚠ **Caution:**
Describes precautions that should be observed to prevent damage to the unit.

Symbols used in the illustrations

- ⚡ : Indicates a part which must be grounded.

⚠ **Warning:**

- These appliances are not accessible to the general public.
- The unit must not be installed by the user. Ask the dealer or an authorized company to install the unit. If the unit is installed improperly, water leakage, electric shock or fire may result.
- Do not alter the unit. It may cause fire, electric shock, injury or water leakage.
- Do not stand on, or place any items on the unit.
- Do not splash water over the unit and do not touch the unit with wet hands. An electric shock may result.
- Do not spray combustible gas close to the unit. Fire may result.
- Do not place a gas heater or any other open-flame appliance where it will be exposed to the air discharged from the unit. Incomplete combustion may result.
- Do not remove the front panel or the fan guard from the outdoor unit when it is running.
- Never repair the unit or transfer it to another site by yourself.
- When you notice exceptionally abnormal noise or vibration, stop operation, turn off the power switch, and contact your dealer.
- Never insert fingers, sticks etc. into the intakes or outlets.
- If you detect odd smells, stop using the unit, turn off the power switch and consult your dealer. Otherwise, a breakdown, electric shock or fire may result.
- This air conditioner is NOT intended for use by children or infirm persons without supervision.

- This appliance is intended to be used by expert or trained users in shops, in light industry and on farms, or for commercial use by lay persons.
- This appliance is not intended for use by persons (including children) with reduced physical, sensory or mental capabilities, or lack of experience and knowledge, unless they have been given supervision or instruction concerning use of the appliance by a person responsible for their safety.
- Children should be supervised to ensure that they do not play with the appliance.
- This appliance can be used by children aged from 8 years and above and persons with reduced physical, sensory or mental capabilities or lack of experience and knowledge if they have been given supervision or instruction concerning use of the appliance in a safe way and understand the hazards involved. Children shall not play with the appliance. Cleaning and user maintenance shall not be made by children without supervision.

⚠ **Caution:**

- Do not use any sharp object to push the buttons, as this may damage the remote controller.
- Never block or cover the indoor or outdoor unit's air inlets or outlets.
- Never wipe the remote controller with benzene, thinner chemical rags, etc.
- Do not operate the unit for a long time in high humidity, e.g. leaving a door or window open. In the cool mode, if the unit is operated in a room with high humidity (80% RH or more) for a long time, water condensed in the air conditioner may drop and wet or damage furniture, etc.
- Do not touch the upper air outlet vane or the lower air outlet damper during operation. Otherwise, condensation may form and the unit may stop operating.

Disposing of the unit

When you need to dispose of the unit, consult your dealer.

2. Parts Names

■ Indoor Unit

		PKFY-WL·VLM
Fan speed		4 speed + Auto
Vane	Steps	5 steps
	Auto swing	○
Louver		Manual
Filter		Normal
Filter cleaning indication		100 hr
Enter the model setting number for the indoor unit you want to operate.*		065 (001)

* For systems that are capable of simultaneous cooling and heating operation, use the setting indicated in parentheses (). For details on the setting procedure, refer to the Installation Manual.

■ PKFY-WL·VLM

Wall Mounted

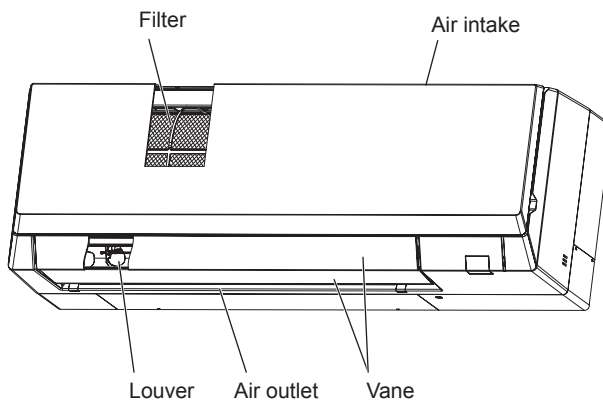

2. Parts Names

■ Wired Remote Controller

Controller interface

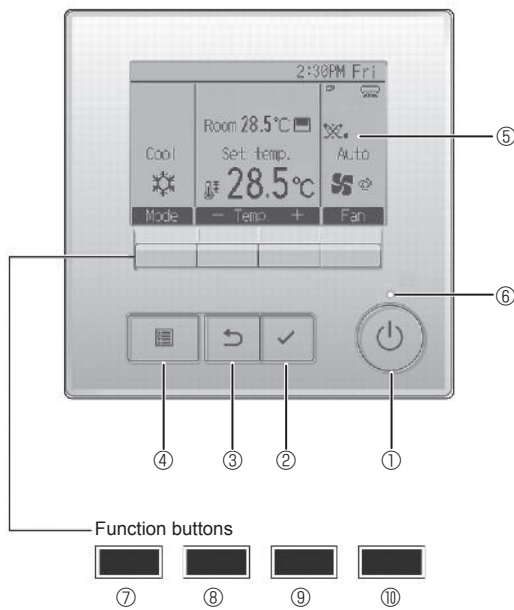

① [ON/OFF] button

Press to turn ON/OFF the indoor unit.

② [SELECT] button

Press to save the setting.

③ [RETURN] button

Press to return to the previous screen.

④ [MENU] button

Press to bring up the Main menu.

⑤ Backlit LCD

Operation settings will appear.

When the backlight is off, pressing any button turns the backlight on and it will stay lit for a certain period of time depending on the screen.

When the backlight is off, pressing any button turns the backlight on and does not perform its function. (except for the [ON/OFF] button)

The functions of the function buttons change depending on the screen.

Refer to the button function guide that appears at the bottom of the LCD for the functions they serve on a given screen.

When the system is centrally controlled, the button function guide that corresponds to the locked button will not appear.

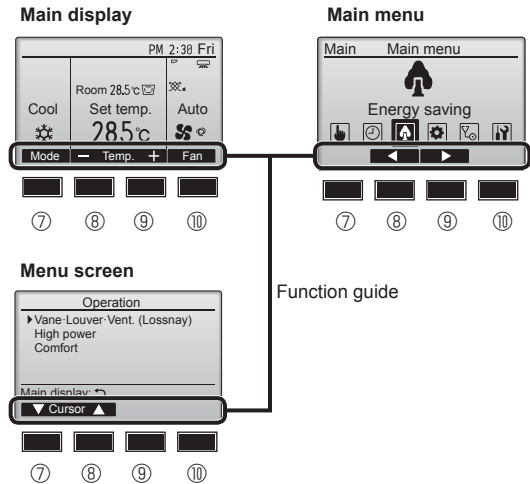

⑥ ON/OFF lamp

This lamp lights up in green while the unit is in operation. It blinks while the remote controller is starting up or when there is an error.

⑦ Function button [F1]

Main display: Press to change the operation mode.

Menu screen: The button function varies with the screen.

⑧ Function button [F2]

Main display: Press to decrease temperature.

Main menu: Press to move the cursor left.

Menu screen: The button function varies with the screen.

⑨ Function button [F3]

Main display: Press to increase temperature.

Main menu: Press to move the cursor right.

Menu screen: The button function varies with the screen.

⑩ Function button [F4]

Main display: Press to change the fan speed.

Menu screen: The button function varies with the screen.

2. Parts Names

Display

The main display can be displayed in two different modes: "Full" and "Basic". The factory setting is "Full". To switch to the "Basic" mode, change the setting on the Main display setting. (Refer to operation manual included with remote controller.)

<Full mode>

* All icons are displayed for explanation.

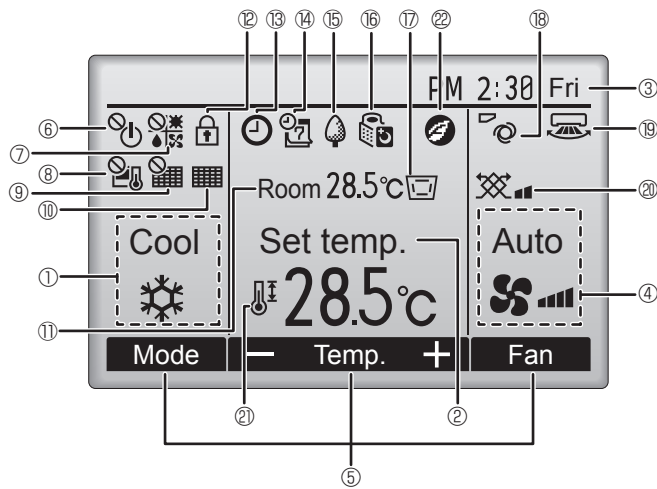

<Basic mode>

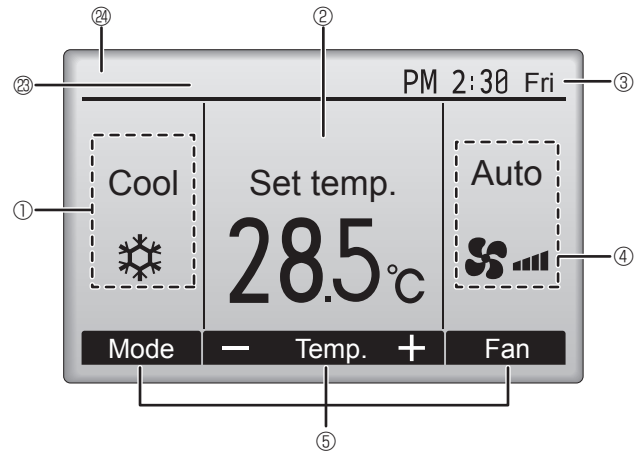

① Operation mode

② Preset temperature

③ Clock

④ Fan speed

⑤ Button function guide

Functions of the corresponding buttons appear here.



Appears when the ON/OFF operation is centrally controlled.



Appears when the operation mode is centrally controlled.



Appears when the preset temperature is centrally controlled.



Appears when the filter reset function is centrally controlled.



Indicates when filter needs maintenance.

⑪ Room temperature



Appears when the buttons are locked.



Appears when the On/Off timer, Night setback, or Auto-off timer function is enabled.

 appears when the timer is disabled by the centralized control system.



Appears when the Weekly timer is enabled.



Appears while the units are operated in the energy-save mode. (Will not appear on some models of indoor units)



Appears while the outdoor units are operated in the silent mode. (This indication is not available for CITY MULTI models.)



Appears when the built-in thermistor on the remote controller is activated to monitor the room temperature (⑪).

 appears when the thermistor on the indoor unit is activated to monitor the room temperature.



Indicates the vane setting.



Indicates the louver setting.



Indicates the ventilation setting.



Appears when the preset temperature range is restricted.



Appears when an energy-saving operation is performed using a "3D i-See sensor" function. (not available)

⑳ Centrally controlled

Appears for a certain period of time when a centrally-controlled item is operated.

㉑ Preliminary error display

An error code appears during the preliminary error.

Most settings (except ON/OFF, mode, fan speed, temperature) can be made from the Main menu. (Refer to Page 8.)

2. Parts Names

■ Wireless Remote-Controller (Optional parts)

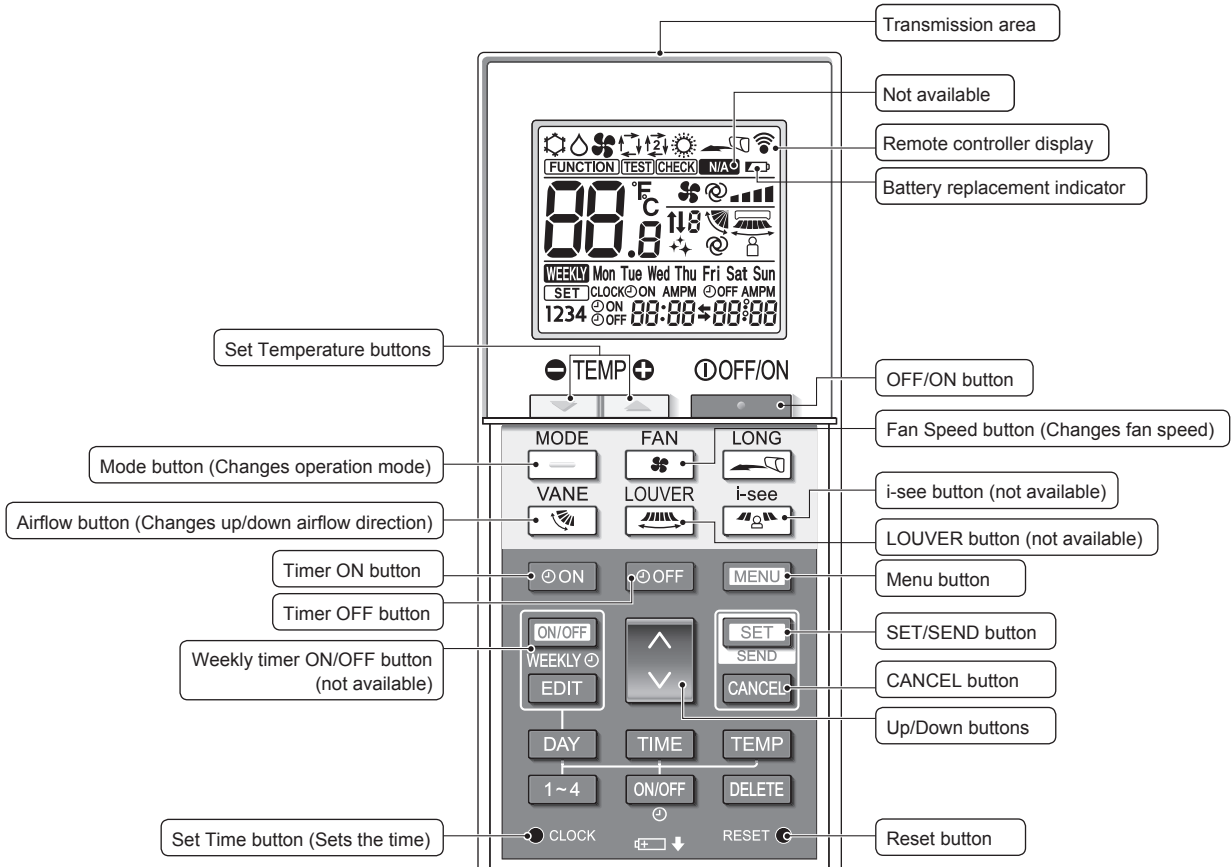

Operation mode

Cool	Dry
Fan	Auto (single set point)
Heat	Auto* (dual set point)

* The initial setting is necessary. Refer to Installation manual.

Temperature setting

The units of temperature can be changed. For details, refer to the Installation manual.

Vane setting

Step 1 Step 2 Step 3 Step 4 Step 5 Swing Auto

Not available
Appears when a non-supported function is selected.

Battery replacement indicator
Appears when the remaining battery power is low.

Fan speed setting

2. Parts Names

Notes (Only for wireless remote controller):

- When using the wireless remote controller, point it towards the receiver on the indoor unit.
- If the remote controller is operated within approximately 2 minutes after power is supplied to the indoor unit, the indoor unit may beep twice as the unit is performing the initial automatic check.
- The indoor unit beeps to confirm that the signal transmitted from the remote controller has been received. Signals can be received up to approximately 7 meters in a direct line from the indoor unit in an area 45° to the left and right of the unit. However, illumination such as fluorescent lights and strong light can affect the ability of the indoor unit to receive signals.
- If the operation lamp near the receiver on the indoor unit is blinking, the unit needs to be inspected. Consult your dealer for service.
- Handle the remote controller carefully! Do not drop the remote controller or subject it to strong shocks. In addition, do not get the remote controller wet or leave it in a location with high humidity.
- To avoid misplacing the remote controller, install the holder included with the remote controller on a wall and be sure to always place the remote controller in the holder after use.
- If the indoor unit beeps 4 times when you are using the wireless remote controller, switch the auto mode setting to the AUTO (single set point) mode or AUTO (dual set point) mode. For details, refer to the included Notice (A5 sheet) or the Installation Manual.

Battery installation/replacement

1. Remove the top cover, insert two LR6 AA batteries, and then install the top cover.

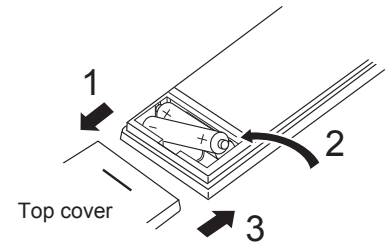

Two LR6 AA batteries
Insert the negative (-) end of
each battery first. Install the
batteries in the correct directions
(+, -)!

2. Press the Reset button.

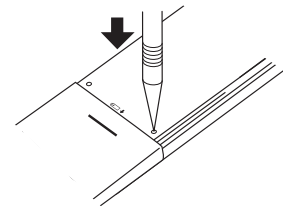

Press the Reset button with an
object that has a narrow end.

After battery installation/replacement, please
set the clock.
Without setting clock, you cannot use a part
of function of remote controller.

3. Operation

■ About the operation method, refer to the operation manual that comes with each remote controller.

3.1. Turning ON/OFF

[ON]

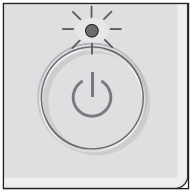

Press the [ON/OFF] button.
The ON/OFF lamp will light up in green, and the operation will start.

When "LED lighting" is set to "No," the ON/OFF lamp will not light up.
* Refer to the installation manual of PAR-40MAA.

[OFF]

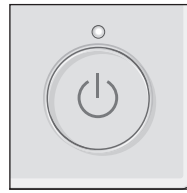

Press the [ON/OFF] button again.
The ON/OFF lamp will come off, and the operation will stop.

Note:
Even if you press the ON/OFF button immediately after shutting down the operation in progress, the air conditioner will not start for about 3 minutes. This is to prevent the internal components from being damaged.

■ Operation status memory

	Remote controller setting
Operation mode	Operation mode before the power was turned off
Preset temperature	Preset temperature before the power was turned off
Fan speed	Fan speed before the power was turned off

■ Settable preset temperature range

Operation mode	Preset temperature range
Cool/Dry	19 ~ 30 °C
Heat	17 ~ 28 °C
Auto (Single set point)	19 ~ 28 °C
Auto (Dual set points)	[Cool] Preset temperature range for the Cool mode [Heat] Preset temperature range for the Heat mode
Fan/Ventilation	Not settable

The settable temperature range varies with the model of outdoor units and remote controller.

3.2. Mode Selection

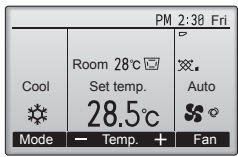

Each pressing of the [F1] button cycles through the following operation modes. Select the desired operation mode.

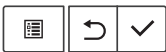
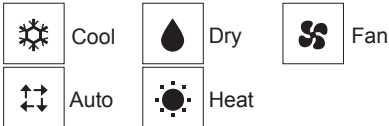

• Operation modes that are not available to the connected outdoor unit models will not appear on the display.

What the blinking mode icon means

The mode icon will blink when other indoor units in the same refrigerant system (connected to the same outdoor unit) are already operated in a different mode. In this case, the rest of the unit in the same group can only be operated in the same mode.

3.3. Temperature setting

<Cool, Dry, Heat, and Auto (single set point)>

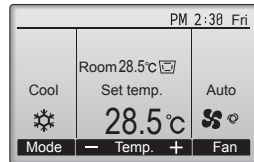
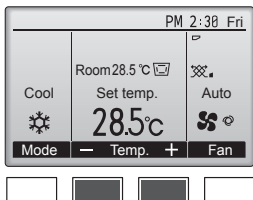

Example display
(Centigrade in 0.5-degree increments)



Press the [F2] button to decrease the preset temperature, and press the [F3] button to increase.

- Refer to the table on this page for the settable temperature range for different operation modes.
- Preset temperature range cannot be set for Fan/Ventilation operation.
- Preset temperature will be displayed either in Centigrade in 0.5- or 1-degree increments, or in Fahrenheit, depending on the indoor unit model and the display mode setting on the remote controller.

Automatic operation (single set point)

- According to a set temperature, cooling operation starts if the room temperature is too hot and heating operation starts if the room temperature is too cold.
- During automatic operation, if the room temperature changes and remains 1.5 °C or more above the set temperature for 3 minutes, the air conditioner switches to cool mode. In the same way, if the room temperature remains 1.5 °C or more below the set temperature for 3 minutes, the air conditioner switches to heat mode.

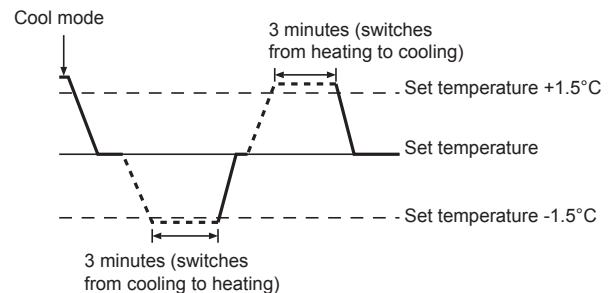

- Because the room temperature is automatically adjusted in order to maintain a fixed effective temperature, cooling operation is performed a few degrees warmer and heating operation is performed a few degrees cooler than the set room temperature once the temperature is reached (automatic energy-saving operation).

3. Operation

<Auto (dual set point) mode>

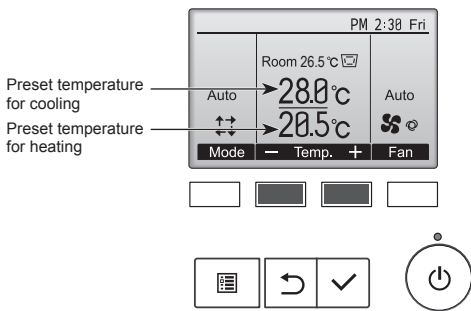

① The current preset temperatures will appear. Press the [F2] or [F3] button to display the Settings screen.

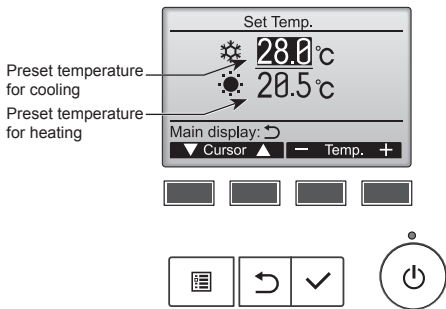

- ② Press the [F1] or [F2] button to move the cursor to the desired temperature setting (cooling or heating). Press the [F3] button to decrease the selected temperature, and [F4] to increase.
- Refer to the table on page 7 for the settable temperature range for different operation modes.
 - The preset temperature settings for cooling and heating in the Auto (dual set point) mode are also used by the Cool/Dry and Heat modes.
 - The preset temperatures for cooling and heating in the Auto (dual set point) mode must meet the conditions below:
 - Preset cooling temperature is higher than preset heating temperature.
 - The minimum temperature difference requirement between cooling and heating preset temperatures (varies with the models of indoor units connected) is met.
 - * If preset temperatures are set in a way that does not meet the minimum temperature difference requirement, both preset temperatures will automatically be changed within the allowable setting ranges.

Navigating through the screens

- To return to the Main screen [RETURN] button

<Auto operation (dual set point) mode>

When the operation mode is set to the Auto (dual set point) mode, two preset temperatures (one each for cooling and heating) can be set. Depending on the room temperature, indoor unit will automatically operate in either the Cool or Heat mode and keep the room temperature within the preset range.

The graph below shows the operation pattern of indoor unit operated in the Auto (dual set point) mode.

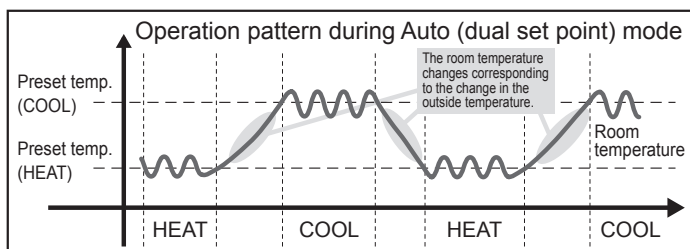

3.4. Fan speed setting

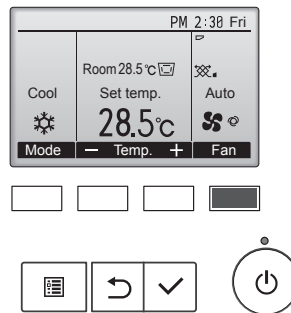

Each pressing of the [F4] button cycles through the following fan speeds.

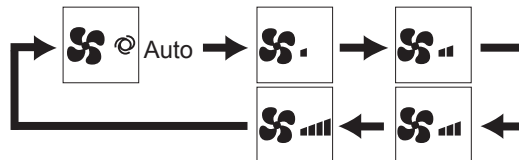

- The available fan speeds depend on the models of connected indoor units.

Note:

- The number of available fan speeds depends on the type of unit connected. Note also that some units do not provide an "Auto" setting.
- In the following cases, the actual fan speed generated by the unit will differ from the speed shown the remote controller display.
 - While the display is showing "STAND BY" or "DEFROST".
 - When the temperature of the heat exchanger is low in the heat mode. (e.g. immediately after heat operation starts)
 - In HEAT mode, when room temperature is higher than the temperature setting.
 - When the unit is in DRY mode.

3.5. Airflow direction setting

3.5.1 Navigating through the Main menu

<Accessing the Main menu>

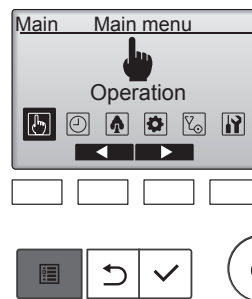

Press the [MENU] button on the Main display. The Main menu will appear.

<Item selection>

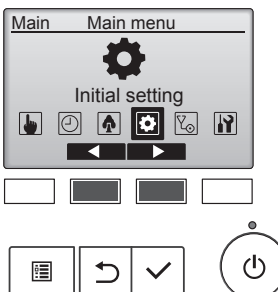

Press [F2] to move the cursor left. Press [F3] to move the cursor right.

3. Operation

<Navigating through the pages>

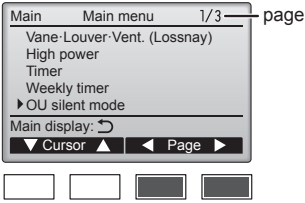

Press [F3] to go to the previous page.
Press [F4] to go to the next page.



<Saving the settings>

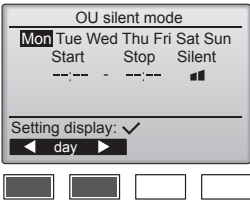

Select the desired item, and press the [SELECT] button.

The screen to set the selected item will appear.



<Exiting the Main menu screen>

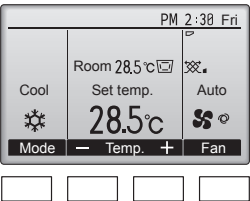

Press the [RETURN] button to exit the Main menu and return to the Main display.

If no buttons are touched for 10 minutes, the screen will automatically return to the Main display. Any settings that have not been saved will be lost.



<Display of unsupported functions>

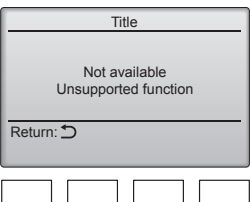

The message at left will appear if the user selects a function not supported by the corresponding indoor unit model.



3.5.2 Vane-Vent. (Lossnay)

<Accessing the menu>

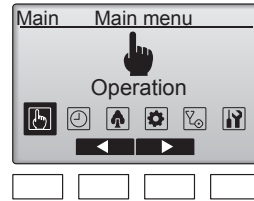

Select "Operation" from the Main menu (refer to page 8), and press the [SELECT] button.

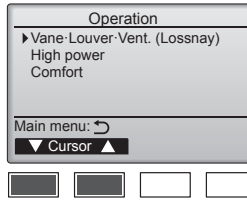

Select "Vane•Louver•Vent. (Lossnay)" from the Operation menu, and press the [SELECT] button.



<Vane setting>

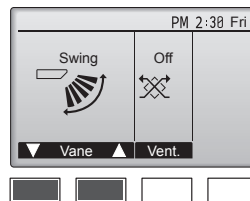

Press the [F1] or [F2] button to go through the vane setting options: "Auto", "Step 1", "Step 2", "Step 3", "Step 4", "Step 5" and "Swing". Select the desired setting.

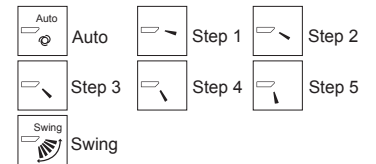

Select "Swing" to move the vanes up and down automatically. When set to "Step 1" through "Step 5", the vane will be fixed at the selected angle.

- **[Ih]** under the vane setting icon
This icon will appear when the vane is set to "Step 2" to "Step 5" and the fan operates at "Mid 1" to "Low" speed during cooling or dry operation (depends on the model).
The icon will go off in an hour, and the vane setting will automatically change.

<Vent. setting>

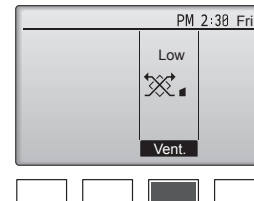

Press the [F3] button to go through the ventilation setting options in the order of "Off", "Low", and "High".
* Settable only when LOSSNAY unit is connected.



- The fan on some models of indoor units may be interlocked with certain models of ventilation units.

en

3. Operation

<Returning to the Operation menu>

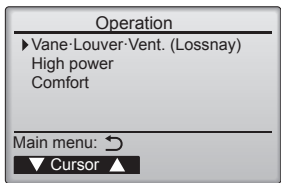

Press the [RETURN] button to go back to the Operation menu.



Note:

- During swing operation, the directional indication on the screen does not change in sync with the directional vanes on the unit.
- Available directions depend on the type of unit connected.
- In the following cases, the actual air direction will differ from the direction indicated on the remote controller display.
 1. While the display is in "STAND BY" or "DEFROST" states.
 2. Immediately after starting heat mode (while the system is waiting for the mode change to take effect).
 3. In heat mode, when room temperature is higher than the temperature setting.

<[Manual] To Change the Airflow's Left/Right Direction>

- * The louver button cannot be used.
- Stop the unit operation, hold the lever of the louver, and adjust to the desired direction.
- * Do not set to the inside direction when the unit is in the cooling or drying mode because there is a risk of condensation and water dripping.

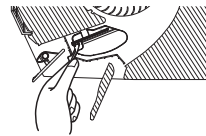

⚠ Caution:

To prevent falls, maintain a stable footing when operating the unit.

3.6. Ventilation

For LOSSNAY combination

- The following 2 patterns of operation is available.
 - Run the ventilator together with indoor unit.
 - Run the ventilator independently.

Note: (for wireless remote controller)

- Running the ventilator independently is not available.
- No indication on the remote controller.

4. Timer

- Timer functions are different by each remote controller.
- For details on how to operate the remote controller, refer to the appropriate operation manual included with each remote controller.

5. Emergency Operation for Wireless Remote-controller

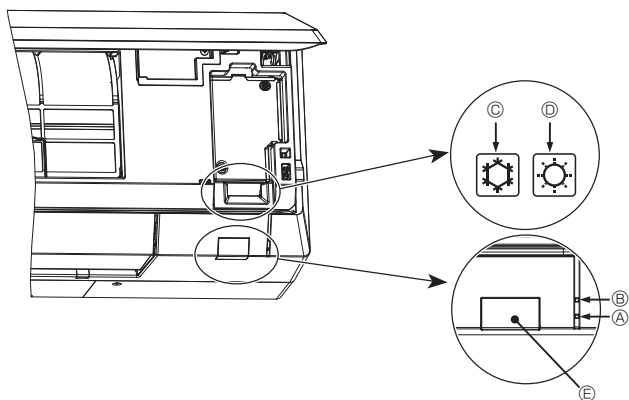

When the remote controller cannot be used

When the batteries of the remote controller run out or the remote controller malfunctions, the emergency operation can be done using the emergency buttons on the grille.

- Ⓐ STANDBY lamp
- Ⓑ OPERATING lamp
- Ⓒ Emergency operation cooling switch
- Ⓓ Emergency operation heating switch
- Ⓔ Receiver

Starting operation

- To operate the cooling mode, press the Ⓒ button for more than 2 seconds.
- To operate the heating mode, press the Ⓓ button for more than 2 seconds.
- Lighting of the OPERATING lamp Ⓑ means the start of operation.

Note:

Details of emergency mode are as shown below. Details of EMERGENCY MODE are as shown below.

Operation mode	COOL	HEAT
Set temperature	24°C	24°C
Fan speed	High	High
Airflow direction	Horizontal (Step 1)	Downward (Step 5)

Stopping operation

- To stop operation, press the Ⓒ button or the Ⓓ button for more than 2 seconds.

6. Care and Cleaning

Filter information

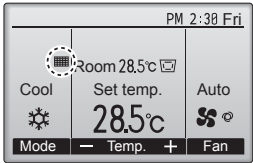

The filter icon will appear on the Main display in the Full mode when it is time to clean the filters.

Wash, clean, or replace the filters when this sign appears. Refer to the indoor unit Instructions Manual for details.

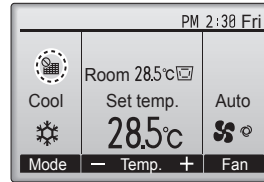

When the filter icon with a power symbol is displayed on the Main display in the Full mode, the system is centrally controlled and the filter sign cannot be reset.

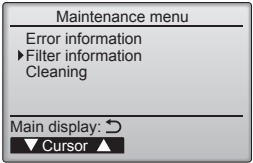

Select "Filter information" from the Maintenance menu, and press the [SELECT] button.

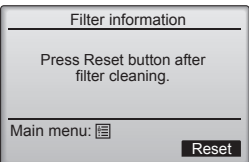

Press the [F4] button to reset filter sign. Refer to the indoor unit Instructions Manual for how to clean the filter.



Select "OK" with the [F4] button.



A confirmation screen will appear.

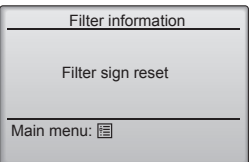

- Navigating through the screens
- To go back to the Main menu..... [MENU] button
 - To return to the previous screen [RETURN] button

If two or more indoor units are connected, filter cleaning timing for each unit may be different, depending on the filter type. The icon will appear when the filter on the main unit is due for cleaning. When the filter sign is reset, the cumulative operation time of all units will be reset. The icon is scheduled to appear after a certain duration of operation, based on the premise that the indoor units are installed in a space with ordinary air quality. Depending on the air quality, the filter may require more frequent cleaning. The cumulative time at which filter needs cleaning depends on the model.

- This indication is not available for wireless remote controller.

Cleaning the filters

- Clean the filters using a vacuum cleaner. If you do not have a vacuum cleaner, tap the filters against a solid object to knock off dirt and dust.
- If the filters are especially dirty, wash them in lukewarm water. Take care to rinse off any detergent thoroughly and allow the filters to dry completely before putting them back into the unit.

Caution:

- Do not dry the filters in direct sunlight or by using a heat source, such as an electric heater: this may warp them.
- Do not wash the filters in hot water (above 50°C), as this may warp them.
- Make sure that the air filters are always installed. Operating the unit without air filters can cause malfunction.

Caution:

- Before you start cleaning, stop operation and turn OFF the power supply.
- Indoor units are equipped with filters to remove the dust of sucked-in air. Clean the filters using the methods shown in the following sketches.

Caution:

- In removing the filter, precautions must be taken to protect your eyes from dust. Also, if you have to climb up on a stool to do the job, be careful not to fall.
- When the filter is removed, do not touch the metallic parts inside the indoor unit, otherwise injury may result.

6. Care and Cleaning

■ PKFY-WL-VLM

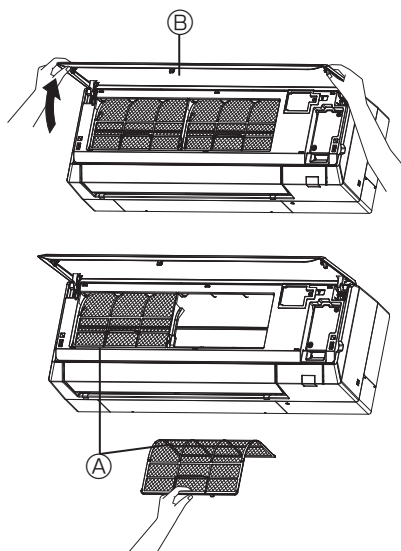

① Pull both the bottom corners of the grille to open the grille, then lift the filter.

Ⓐ Filter

Ⓑ Grille

Cleaning the indoor unit

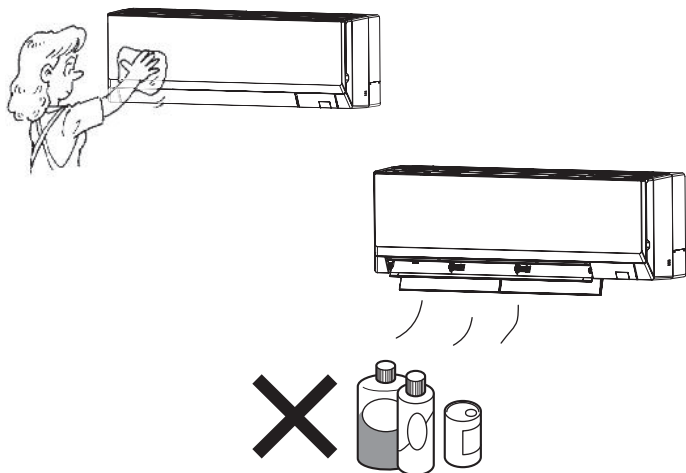







- Wipe the outside of the unit with a clean, dry, soft cloth.
- Clean off any oil stains or finger marks using a neutral household detergent (such as dishwashing liquid or laundry detergent).

⚠ Caution:

Never use gasoline, benzene, thinner, scouring powder or any type of non-neutral detergent, as these substances may damage the unit's case.

7. Troubleshooting

Having trouble?	Here is the solution. (Unit is operating normally.)
Air conditioner does not heat or cool well.	<ul style="list-style-type: none"> ■ Clean the filter. (Airflow is reduced when the filter is dirty or clogged.) ■ Check the temperature adjustment and adjust the set temperature. ■ Make sure that there is plenty of space around the outdoor unit. Is the indoor unit air inlet or outlet blocked? ■ Has a door or window been left open?
When heating or cooling operation starts, warm or cool air does not blow from the indoor unit soon.	<ul style="list-style-type: none"> ■ Warm or cool air does not blow until the indoor unit has sufficiently warmed up or cooled down.
During heat mode, the air conditioner stops before the set room temperature is reached.	<ul style="list-style-type: none"> ■ When the outdoor temperature is low and the humidity is high, frost may form on the outdoor unit. If this occurs, the outdoor unit performs a defrosting operation. Normal operation should begin after approximately 10 minutes.
Airflow up/down direction changes during operation or airflow up/down direction cannot be set.	<ul style="list-style-type: none"> ■ During cool mode, the vanes automatically move to the step 1 position after 1 hour when the vane is set to "Step 2" to "Step 5". This is to prevent water from forming and dripping from the vanes. ■ During heat mode, the vanes automatically move to the step 1 position when the airflow temperature is low or during defrosting mode.
When the airflow up/down direction is changed, the vanes always move up and down past the set position before finally stopping at the position.	<ul style="list-style-type: none"> ■ When the airflow up/down direction is changed, the vanes move to the set position after detecting the base position.
A flowing water sound or occasional hissing sound is heard.	<ul style="list-style-type: none"> ■ These sounds can be heard when refrigerant is flowing in the air conditioner or when the refrigerant flow is changing.
A cracking or creaking sound is heard.	<ul style="list-style-type: none"> ■ These sounds can be heard when parts rub against each other due to expansion and contraction from temperature changes.
The room has an unpleasant odor.	<ul style="list-style-type: none"> ■ The indoor unit draws in air that contains gases produced from the walls, carpeting, and furniture as well as odors trapped in clothing, and then blows this air back into the room.
A white mist or vapor is emitted from the indoor unit.	<ul style="list-style-type: none"> ■ If the indoor temperature and the humidity are high, this condition may occur when operation starts. ■ During defrosting mode, cool airflow may blow down and appear like a mist.
Water or vapor is emitted from the outdoor unit.	<ul style="list-style-type: none"> ■ During cool mode, water may form and drip from the cool pipes and joints. ■ During heat mode, water may form and drip from the heat exchanger. ■ During defrosting mode, water on the heat exchanger evaporates and water vapor may be emitted.
The air conditioner does not operate even though the ON/OFF button is pressed. The operation mode display on the remote controller disappears.	<ul style="list-style-type: none"> ■ Is the power switch of the indoor unit turned off? Turn on the power switch.
"  " appears in the remote controller display.	<ul style="list-style-type: none"> ■ During central control, " " appears in the remote controller display and air conditioner operation cannot be started or stopped using the remote controller.
When restarting the air conditioner soon after stopping it, it does not operate even though the ON/OFF button is pressed.	<ul style="list-style-type: none"> ■ Wait approximately 3 minutes. (Operation has stopped to protect the air conditioner.)
Air conditioner operates without the ON/OFF button being pressed.	<ul style="list-style-type: none"> ■ Is the on timer set? Press the ON/OFF button to stop operation. ■ Is the air conditioner connected to a central remote controller? Consult the concerned people who control the air conditioner. ■ Does " " appear in the remote controller display? Consult the concerned people who control the air conditioner. ■ Has the auto recovery feature from power failures been set? Press the ON/OFF button to stop operation.
Air conditioner stops without the ON/OFF button being pressed.	<ul style="list-style-type: none"> ■ Is the off timer set? Press the ON/OFF button to restart operation. ■ Is the air conditioner connected to a central remote controller? Consult the concerned people who control the air conditioner. ■ Does " " appear in the remote controller display? Consult the concerned people who control the air conditioner.
Remote controller timer operation cannot be set.	<ul style="list-style-type: none"> ■ Are timer settings invalid? If the timer can be set,  or  appears in the remote controller display.
"PLEASE WAIT" appears in the remote controller display.	<ul style="list-style-type: none"> ■ The initial settings are being performed. Wait approximately 3 minutes.
An error code appears in the remote controller display.	<ul style="list-style-type: none"> ■ The protection devices have operated to protect the air conditioner. ■ Do not attempt to repair this equipment by yourself. Turn off the power switch immediately and consult your dealer. Be sure to provide the dealer with the model name and information that appeared in the remote controller display.
Draining water or motor rotation sound is heard.	<ul style="list-style-type: none"> ■ When cooling operation stops, the drain pump operates and then stops. Wait approximately 3 minutes.

7. Troubleshooting

Having trouble?	Here is the solution. (Unit is operating normally.)												
Noise is louder than specifications.	<ul style="list-style-type: none"> The indoor operation sound level is affected by the acoustics of the particular room as shown in the following table and will be higher than the noise specification, which was measured in an echo-free room. <table border="1"> <thead> <tr> <th></th> <th>High sound-absorbing rooms</th> <th>Normal rooms</th> <th>Low sound-absorbing rooms</th> </tr> </thead> <tbody> <tr> <td>Location examples</td> <td>Broadcasting studio, music room, etc.</td> <td>Reception room, hotel lobby, etc.</td> <td>Office, hotel room</td> </tr> <tr> <td>Noise levels</td> <td>3 to 7 dB</td> <td>6 to 10 dB</td> <td>9 to 13 dB</td> </tr> </tbody> </table>		High sound-absorbing rooms	Normal rooms	Low sound-absorbing rooms	Location examples	Broadcasting studio, music room, etc.	Reception room, hotel lobby, etc.	Office, hotel room	Noise levels	3 to 7 dB	6 to 10 dB	9 to 13 dB
	High sound-absorbing rooms	Normal rooms	Low sound-absorbing rooms										
Location examples	Broadcasting studio, music room, etc.	Reception room, hotel lobby, etc.	Office, hotel room										
Noise levels	3 to 7 dB	6 to 10 dB	9 to 13 dB										
Nothing appears in the wireless remote controller display, the display is faint, or signals are not received by the indoor unit unless the remote controller is close.	<ul style="list-style-type: none"> The batteries are low. Replace the batteries and press the Reset button. If nothing appears even after the batteries are replaced, make sure that the batteries are installed in the correct directions (+, -). 												
After battery installation/replacement of remote controller, part of function cannot be used.	<ul style="list-style-type: none"> Please check that the clock setting is completed. If clock setting is not done, please complete. 												
The operation lamp near the receiver for the wireless remote controller on the indoor unit is blinking.	<ul style="list-style-type: none"> The self diagnosis function has operated to protect the air conditioner. Do not attempt to repair this equipment by yourself. Turn off the power switch immediately and consult your dealer. Be sure to provide the dealer with the model name. 												
Warm air blows from the indoor unit intermittently when heating mode is off or during fan mode.	<ul style="list-style-type: none"> When another indoor unit is operating in heating mode, the control valve opens and closes occasionally to maintain stability in the air conditioning system. This operation will stop after a while. * If this will cause an undesirable rise in the room temperature in small rooms, etc., stop the operation of the indoor unit temporarily. 												
The wireless remote controller does not operate (the indoor unit beeps 4 times).	<ul style="list-style-type: none"> Switch the auto mode setting to the AUTO (single set point) mode or AUTO (dual set point) mode. For details, refer to the included Notice (A5 sheet) or the Installation Manual. 												

⚠ Warning:

If the air conditioner operates but does not cool or heat (depending on model) the room, consult your dealer since there may be a refrigerant leak. Be sure to ask the service representative whether there is refrigerant leakage or not when repairs are carried out. The refrigerant charged in the air conditioner is safe. Refrigerant normally does not leak. However, if refrigerant gas leaks indoors, and comes into contact with the fire of a fan heater, space heater, stove, etc., harmful substances will be generated.

8. Specifications

Range of application

The range of working temperatures for both the indoor and outdoor units of the series Y, R2, Multi-S is as below.

■ PKFY-WL-VLM-E

Model		WL10	WL15	WL20	WL25	WL32	WL40	
Power source (Voltage/Frequency)	<V/Hz>	~N 220-230-240/50, 220/60						
Capacity (Cooling/Heating)	<kW>	1.2/1.4	1.7/1.9	2.2/2.5	2.8/3.2	3.6/4.0	4.5/5.0	
Dimension (Height)	<mm>	299				299		
Dimension (Width)	<mm>	773				898		
Dimension (Depth)	<mm>	237				237		
Net weight	<kg>	11				13		
Fan Airflow rate (Low-Middle2-Middle1-High)	<m ³ /min>	3.3-3.8-4.1-4.5	3.3-3.8-4.3-4.9	4.0-5.0-6.0-7.0	4.0-5.4-7.0-8.4	6.3-7.6-9.0-10.4	6.4-8.2-10.0-11.9	
Noise level (Low-Middle2-Middle1-High)	<dB>	22-26-28-30	22-26-29-32	22-28-33-36	22-30-36-41	29-34-38-41	30-36-41-45	

Model		WL10	WL15	WL20	WL25	WL32	WL40	
Cooling capacity	sensible	$P_{rated,c}$ <kW>	0.98	1.34	1.73	2.19	2.68	3.49
	latent	$P_{rated,c}$ <kW>	0.22	0.36	0.47	0.61	0.92	1.01
Heating capacity		$P_{rated,h}$ <kW>	1.40	1.90	2.50	3.20	4.00	5.00
Total electric power input		P_{elec} <kW>	0.02	0.02	0.03	0.04	0.04	0.05
Sound power level (per speed setting, if applicable)		LWA <dB>	43-46-48-51	44-47-50-54	45-50-54-57	46-52-58-62	51-56-59-62	53-58-61-65

(EU)2016/2281

Note

- Operation temperature of indoor unit.
Cooling mode: 15 °CWB - 24 °CWB
Heating mode: 15 °CDB - 27 °CDB
- Cooling/Heating capacity indicates the maximum value at operation under the following condition.
Cooling: Indoor 27 °C DB/19 °C WB, Outdoor 35 °C DB
Heating: Indoor 20 °C DB, Outdoor 7 °C DB/6 °C WB

EC DECLARATION OF CONFORMITY

MITSUBISHI ELECTRIC CONSUMER PRODUCTS (THAILAND) CO., LTD
700/406 MOO 7, TAMBON DON HUA ROH, AMPHUR MUANG, CHONBURI 20000, THAILAND

hereby declares under its sole responsibility that the air conditioners and heat pumps described below for use in residential, commercial and light-industrial environments:

MITSUBISHI ELECTRIC, PKFY-WL10VLM-E*, PKFY-WL15VLM-E*, PKFY-WL20VLM-E*
PKFY-WL25VLM-E*, PKFY-WL32VLM-E*, PKFY-WL40VLM-E*

Note: Its serial number is on the nameplate of the product.

Directives

2014/35/EU: Low Voltage
2006/42/EC: Machinery
2014/30/EU: Electromagnetic Compatibility
2011/65/EU, (EU) 2015/863 and (EU) 2017/2102: RoHS Directive

Issued:
THAILAND

1 Sep. 2019

Akira HIDAKA
Manager, Quality Assurance Department

<ENGLISH>

English is original. The other languages versions are translation of the original.

 **CAUTION**

- Refrigerant leakage may cause suffocation. Provide ventilation in accordance with EN378-1.
- Be sure to wrap insulation around the piping. Direct contact with the bare piping may result in burns or frostbite.
- Never put batteries in your mouth for any reason to avoid accidental ingestion.
- Battery ingestion may cause choking and/or poisoning.
- Install the unit on a rigid structure to prevent excessive operation sound or vibration.
- Noise measurement is carried out in accordance with JIS C9612, JIS B8616, ISO 5151(T1), and ISO 13523(T1).

■ The serial number is indicated on the SPEC NAME PLATE.



Sequential number for each unit: 00001-99999

A (indoor unit)

Month of manufacture: 4, 5, 6, 7, 8, 9, X (10), Y (11), Z (12), 1, 2, 3

Last digit of the company's fiscal year (western calendar) : 2014 → 4, 2015 → 5

This product is designed and intended for use in the residential, commercial and light-industrial environment.

www.mitsubishi-electric.co.nz | 0800 784 382

Wellington

Head Office
1 Parliament Street
PO Box 30772
Lower Hutt 5040

Phone 04 560 9147

Auckland

Unit 1 / 4 Walls Road
PO Box 12726
Penrose
Auckland 1642

Phone 09 526 9347

Christchurch

44 Halwyn Drive
PO Box 16904
Hornby
Christchurch 8441

Phone 03 341 2837

MITSUBISHI ELECTRIC CORPORATION

Название Компании: ООО «Мицубиси Электрик (РУС)»

Адрес: 115114, Российская Федерация, г. Москва, ул. Летниковская, д. 2, стр. 1, 5 этаж

HEAD OFFICE: TOKYO BUILDING, 2-7-3, MARUNOUCHI, CHIYODA-KU, TOKYO 100-8310, JAPAN